



4LV Series - 150 / 170 / 195

Configuration	4-stroke, vertical, water-cooled diesel engine	
Maximum output at crankshaft*	110 kW@3500 rpm	[150 mhp@3500 rpm]
	125 kW@3500 rpm	[170 mhp@3500 rpm]
	143 kW@3500 rpm	[195 mhp@3500 rpm]
Displacement	2.755 L	[168 cu in]
Bore x stroke	92 mm x 103.6 mm	[3.6 in x 4 in]
Cylinders	4 in-line	
Combustion system	Direct injection with Denso common rail system	
Low idle rpm	750 rpm	
Aspiration	Turbocharger with charge-air cooler	
Starting system	Electric starting 12V – 2 kW	
Alternator	Denso 12V - 130A	
Cooling system	Fresh water cooling by centrifugal fresh water pump	
	Sea water cooling by rubber impeller seawater pump	
Lubrication system	Enclosed, forced lubricating system	
Direction of rotation [crankshaft]	Counterclockwise viewed from stern	
Dry weight without gear**	332 kg	[732 lbs]
Emission compliance	EU: RCD 2, BSO II, EMC	US: EPA Tier 3
Engine mounting	Rubber type flexible mounting	

NOTE:

Fuel condition: Density at 15°C = 0.84 g/cm³: 1 kW = 1.3596 mhp = 1.3410 HP

* Fuel temperature 40°C at the inlet of the fuel injection pump [ISO 8665: 2006]

** Including damper disk

Technical data is according to ISO 8665: 2006

DIMENSIONS

Right side view

Rear view

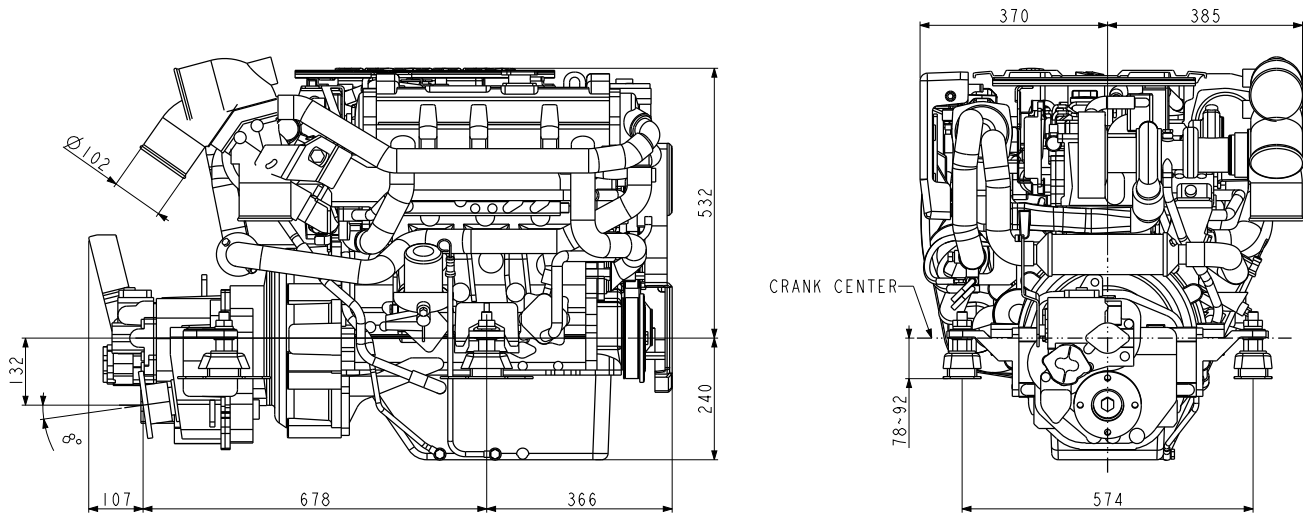

4LV195 with KMH50A marine gear



PERFORMANCE CURVES

4LV150 Torque curve

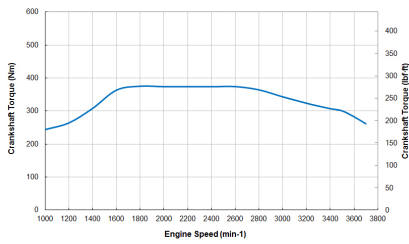

4LV150 Output Power curve

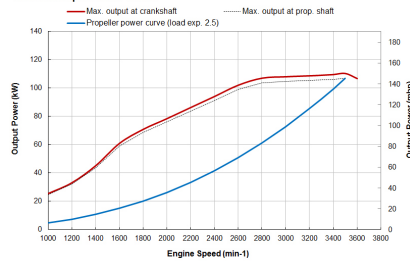

4LV150 Fuel consumption (load exp. 2.5)

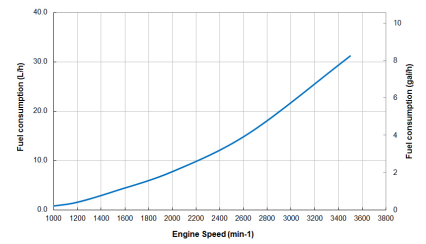

4LV170 Torque curve

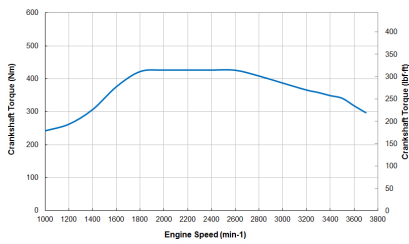

4LV170 Output Power curve

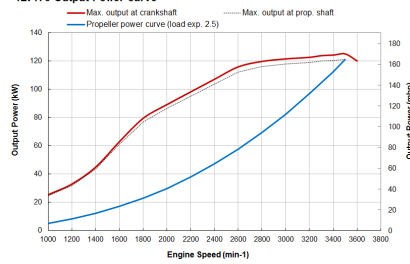

4LV170 Fuel consumption (load exp. 2.5)

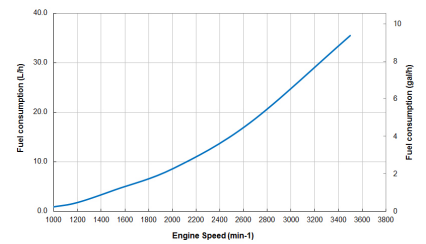

4LV195 Torque curve

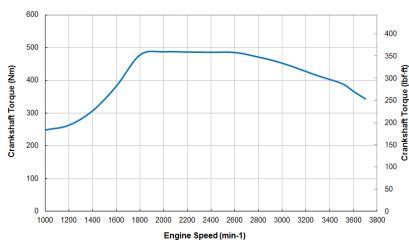

4LV195 Output Power curve

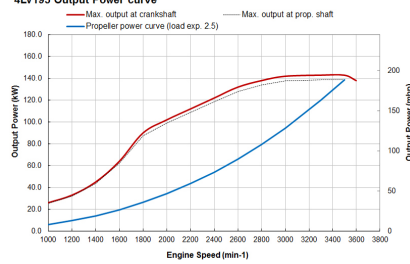

4LV195 Fuel consumption (load exp. 2.5)

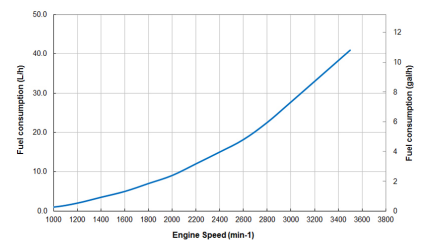

MARINE GEARS*

Model	KMH50A [down angle: 8°]			KMH50V [V-drive, angle: 12°]		
Type	Hydraulic, multi disk clutch			Hydraulic, multi disk clutch		
Dry Weight**	52 kg [115 lbs]			75 kg [165 lbs]		
Reduction Ratio [fwd/asn]	1.67/1.67	2.13/2.13	2.43/2.43	1.22/1.22	1.58/1.58	2.08/2.08 2.47/2.47
Propeller speed [fwd/asn]	2096/2096	1643/1643	1440/1440	2869/2869	2215/2215	1683/1683 1417/1417
Direction of rotation [viewed from stern]	Clockwise & counterclockwise			Clockwise & counterclockwise		
Dry weight - engine & gear	384 kg [846 lbs]			407 kg [897 lbs]		
Length engine and gear/drive	1151 mm [45.3 in]			1151 mm [45.3 in]		

*For other configurations, consult your local Yanmar distributor.
 **Dry weight includes cooler and brackets

ACCESSORIES

Standard Package

- Exhaust mixing elbow [L-type]
- Alternator 12V - 130A
- B25 panel
- Oil sensor for instrument panel
- Mechanical throttle sensor
- Set of flexible engine mounts
- Fresh water expansion tank
- Belt safety cover
- Engine topcover for protection
- Operation manual

Optional

- High-riser mixing elbow [instead of L-elbow]
- Secondary alternator 12V - 150A or 24V - 85A
- Multistage secondary alternator 12V - 130A or 24V - 110A
- Semi 2-Pole Electrical Installation
- Hot water connection
- Opposite dipstick
- Fuel pre-filter with water separator
- C-Type Trolling Valve KMH50
- Extension harness [3m, 5m, 10m, 20m]
- C35 panel
- Mechanical sidemount control head

- VC10 Vessel Control System
- Second station
- NMEA2000 Engine monitoring system
- Electronic Side Mount CH instead of Top Mount
- SOLAS including Certificate (Factory fit only)
- Man Over Board Switch (single)
- On Board Spare Parts Kit 4LV
- Second station
- NMEA2000 Engine monitoring system
- JC20 Inboard Joystick

NOTE: All data subject to change without notice. Text and illustrations are not binding.